

Circulo P 45 | 24W

Product Reference

Environment Indoor

Installation Ceiling Suspended

Construction & Materials

Housing Extruded and Sheet Aluminium

Primary Lens -

Primary Reflector White Optics

Secondary Reflector -

Body Finish White,Black,Custom

Diffuser Opal PC, Microprismatic

Antiglare Baffle -

Thermal Management

Heat Sink Material Aluminium

Cooling Technique Passive Cooling

Optical System

Beam Direction General Diffuse

Tilt No

Swivel No

Electrical System

Driven with Constant Current Driver

Input Voltage/Hz 220V- 240V/50-60Hz

Control Gear Included

Mounting Integral

LED Power Watts 20.7W

System Power Watts 23.8W

Operating Voltage Vin 220-240 Vac

Power Factor p.f. > 0.95

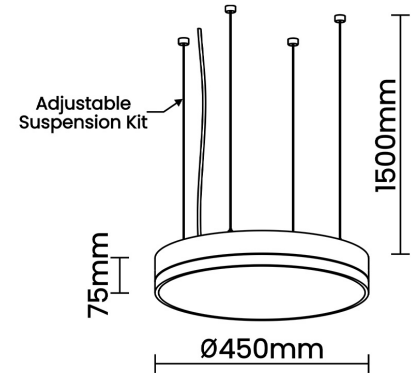

Light Distribution

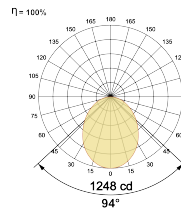

LED Technology

Binning 3 Step MacAdam

LED Life Time @ L80/B10 >50000 hours

Colour Rendering (CRI) CRI80,CRI90

Led Type SMD mid power

LED Fitted Osram/Samsung Mid power LED array 43V-48Vdc/500mA

Controls

Standard Switchable On/Off

Optional DDIM,CASAMBI,Non Dimmable

Ordering Details

Code Example:	Name	Watt	CCT	CRI	Angle	Finish	Control
	Circulo P 45	24W	WW27K	CRI80	94°	SWH	On/Off

Select one from each column with highlighted values to create the ordering code

NAME	WATT	LUMEN	EFFICACY	CCT	CRI	ANGLE	FINISH	CONTROL
Circulo P 45	24W	2856	120	2700K	WW27K	94°	White	Non Dimmable
		2904	122	3000K	WW30K		Black	Dali Dimmable
		2975	125	4000K	NW40K		Custom	Casambi
		3023	127	5700K	CW57K			
				2700K-5700K	TW			
Circulo P 45	24W			WW27K	CRI80	94°	SWH	On/Off

