

Square Cut | 15W

Product Reference

Environment Indoor

Installation Ceiling Recess

Construction & Materials

Housing Die Cast Aluminium

Primary Lens -

Primary Reflector White Optics

Secondary Reflector -

Body Finish White

Diffuser Premium high-transmission opal

Antiglare Baffle -

Thermal Management

Heat Sink Material Die cast Aluminium

Cooling Technique Passive Cooling

Optical System

Beam Direction General Diffuse

Tilt No

Swivel No

Electrical System

Driven with Constant Current Driver

Input Voltage/Hz 220V- 240V/50-60Hz

Control Gear Included

Mounting Remote

LED Power Watts 12.4W

System Power Watts 14.2W

Operating Voltage Vin 220-240 Vac

Power Factor p.f. > 0.95

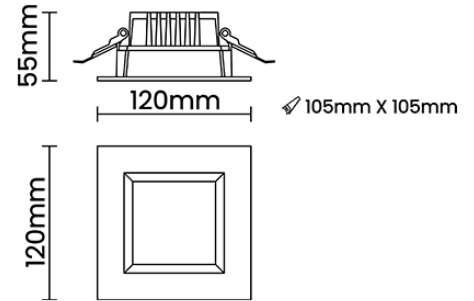
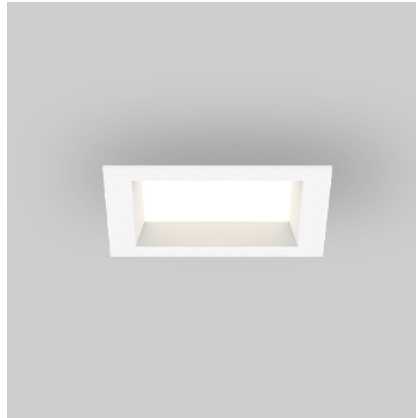

Light Distribution

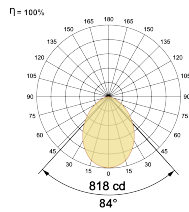

LED Technology

Binning 3 Step MacAdam

LED Life Time @ L80/B10 >50000 hours

Colour Rendering (CRI) CRI80,CRI90

Led Type SMD mid power

LED Fitted Osram/Samsung Mid power LED array 32V-38Vdc/350mA

Controls

Standard Switchable On/Off

Optional PDIM,DDIM,BTTM,CASAMBI,Non Dimmable

Ordering Details

Code Example:	Name	Watt	CCT	CRI	Angle	Finish	Control
	Square Cut	15W	WW27K	CRI80	84°	SWH	On/Off

Select one from each column with highlighted values to create the ordering code

NAME	WATT	LUMEN	EFFICACY	CCT	CRI	ANGLE	FINISH	CONTROL	
Square Cut	15W	1477	104	2700K	WW27K	84°	White SWH	Non Dimmable	On/Off
		1519	107	3000K	WW30K			Phase Dimmable	PDIM
		1605	113	4000K	NW40K			Dali Dimmable	DDIM
		1676	118	5700K	CW57K			Bluetooth Dimmable	BTTM
				2700K-5700K	TW			Casambi	CBTM
Square Cut	15W			WW27K	CRI80	84°	SWH	On/Off	