

Cyclop Central 90 | 66W

Product Reference

Environment Indoor

Installation Ceiling Suspended

Construction & Materials

Housing Extruded and Sheet Aluminium

Primary Lens -

Primary Reflector White Optics

Secondary Reflector -

Body Finish White,Black,Custom

Diffuser Premium high-transmission opal

Antiglare Baffle -

Thermal Management

Heat Sink Material Aluminium

Cooling Technique Passive Cooling

Optical System

Beam Direction General Diffuse

Tilt No

Swivel No

Electrical System

Driven with Constant Current Driver

Input Voltage/Hz 220V- 240V/50-60Hz

Control Gear Included

Mounting Integral

LED Power Watts 58.0W

System Power Watts 66.7W

Operating Voltage V_{in} 220-240 Vac

Power Factor p.f. > 0.95

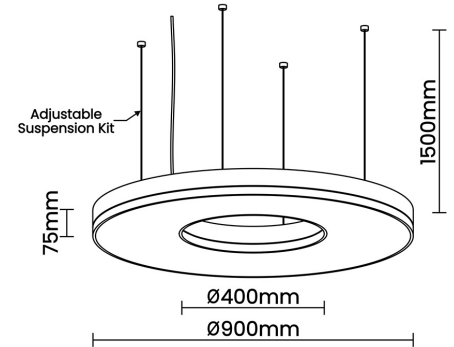

Light Distribution

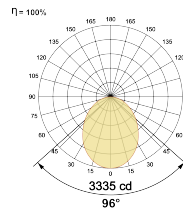

LED Technology

Binning 3 Step MacAdam

LED Life Time @ L80/B10 >50000 hours

Colour Rendering (CRI) CRI80,CRI90

Led Type SMD mid power

LED Fitted Osram/Samsung Mid power LED array 42V-48Vdc/1400mA

Controls

Standard Switchable On/Off

Optional DDIM,CASAMBI,Non Dimmable

Ordering Details

Code Example:	Name	Watt	CCT	CRI	Angle	Finish	Control
	Cyclop Central 90	66W	WW27K	CRI80	96°	SWH	On/Off

Select one from each column with highlighted values to create the ordering code

NAME	WATT	LUMEN	EFFICACY	CCT	CRI	ANGLE	FINISH	CONTROL
Cyclop Central 90	66W	7937	119	2700K	WW27K	96°	White	Non Dimmable
		8207	123	3000K	WW30K		Black	Dali Dimmable
		8671	130	4000K	NW40K		Custom	Casambi
		8938	134	5700K	CW57K			
Cyclop Central 90	66W			WW27K	CRI80	96°	SWH	On/Off

