

# Mojo 50 HGB MD | 18W

## Product Reference

Environment Indoor

Installation Track Mounted

## Construction & Materials

Housing Aluminium

Primary Lens -

Primary Reflector PC metallised

Secondary Reflector Anodised

Body Finish White,Black

Diffuser -

Antiglare Baffle -

## Thermal Management

Heat Sink Material Die cast Aluminium

Cooling Technique Passive Cooling

## Optical System

Beam Direction Adjustable

Tilt Yes

Swivel Yes

## Electrical System

Driven with Constant Current Driver

Input Voltage/Hz 220V- 240V/50-60Hz

Control Gear Included

Mounting Integral

LED Power Watts 15.7W

System Power Watts 18.0W

Operating Voltage Vin 220-240Vac

Power Factor p.f. >0.95

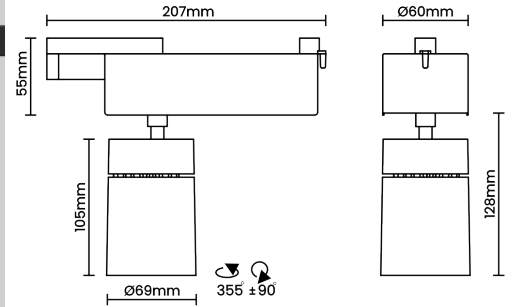

## Light Distribution

## LED Technology

Binning 3 Step MacAdam

LED Life Time @ L80/B10 >50000 hours

Colour Rendering (CRI) CRI80,CRI90

Led Type COB

LED Fitted Cree COB LED 33V-36Vdc/450mA

## Controls

Standard Switchable On/Off

Optional DDIM,BTTM,CASAMBI

## Ordering Details

Code Example:	Name	Watt	CCT	CRI	Angle	Finish	Control
	Mojo 50 HGB MD	18W	WW27K	CRI80	27°	SWH	DDIM

Select one from each column with highlighted values to create the ordering code

NAME	WATT	LUMEN	EFFICACY	CCT	CRI	ANGLE	FINISH	CONTROL
Mojo 50 HGB MD	18W	1440	80	2700K	WW27K	27°	White	Dali Dimmable
		1494	83	3000K	WW30K		Black	Bluetooth Dimmable
		1566	87	4000K	NW40K			Casambi
		1602	89	5700K	CW57K			
				2700K-5700K	TW			
Mojo 50 HGB MD	18W			WW27K	CRI80	27°	SWH	DDIM