

Mojo 65 ITA MD | 28W

Product Reference

Environment Indoor

Installation Track Mounted

Construction & Materials

Housing Aluminium

Primary Lens -

Primary Reflector PC metallised

Secondary Reflector Anodised

Body Finish White,Black

Diffuser -

Antiglare Baffle -

Thermal Management

Heat Sink Material Die cast Aluminium

Cooling Technique Passive Cooling

Optical System

Beam Direction Adjustable

Tilt Yes

Swivel Yes

Electrical System

Driven with Constant Current Driver

Input Voltage/Hz 220V- 240V/50-60Hz

Control Gear Included

Mounting Integral

LED Power Watts 24.6W

System Power Watts 28.3W

Operating Voltage Vin 220-240Vac

Power Factor p.f. >0.95

Ordering Details

Code Example:	Name	Watt	CCT	CRI	Angle	Finish	Control
	Mojo 65 ITA MD	28W	WW27K	CRI80	27°	SWH	On/Off

Select one from each column with highlighted values to create the ordering code

NAME	WATT	LUMEN	EFFICACY	CCT		CRI	ANGLE	FINISH		CONTROL	
Mojo 65 ITA MD	28W	2434	86	2700K	WW27K	CRI80	27°	White	SWH	Non Dimmable	On/Off
		2519	89	3000K	WW30K	CRI90		Black	SBL		
		2660	94	4000K	NW40K						
		2717	96	5700K	CW57K						
Mojo 65 ITA MD	28W			WW27K	CRI80	27°	SWH		On/off		

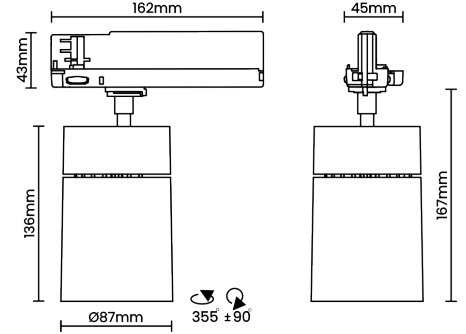

Light Distribution

LED Technology

Binning 3 Step MacAdam

LED Life Time @ L80/B10 >50000 hours

Colour Rendering (CRI) CRI80,CRI90

Led Type COB

LED Fitted Cree COB LED 33V-36Vdc/700mA

Controls

Standard Switchable On/Off

Optional -