

Mojo 65 HGB MD | 20W

Product Reference

Environment Indoor

Installation Track Mounted

Construction & Materials

Housing Aluminium

Primary Lens -

Primary Reflector PC metallised

Secondary Reflector Anodised

Body Finish White,Black

Diffuser -

Antiglare Baffle -

Thermal Management

Heat Sink Material Die cast Aluminium

Cooling Technique Passive Cooling

Optical System

Beam Direction Adjustable

Tilt Yes

Swivel Yes

Electrical System

Driven with Constant Current Driver

Input Voltage/Hz 220V- 240V/50-60Hz

Control Gear Included

Mounting Integral

LED Power Watts 17.6W

System Power Watts 20.2W

Operating Voltage Vin 220-240Vac

Power Factor p.f. >0.95

Ordering Details

Code Example:	Name	Watt	CCT	CRI	Angle	Finish	Control
	Mojo 65 HGB MD	20W	WW27K	CRI80	27°	SWH	DDIM

Select one from each column with highlighted values to create the ordering code

NAME	WATT	LUMEN	EFFICACY	CCT		CRI	ANGLE	FINISH		CONTROL	
Mojo 65 HGB MD	20W	1838	91	2700K	WW27K	CRI80	27°	White	SWH	Dali Dimmable	DDIM
		1899	94	3000K	WW30K	CRI90		Black	SBL	Bluetooth Dimmable	BTTM
		2000	99	4000K	NW40K					Casambi	CBTM
		2040	101	5700K	CW57K						
Mojo 65 HGB MD	20W			WW27K		CRI80	27°	SWH		DDIM	

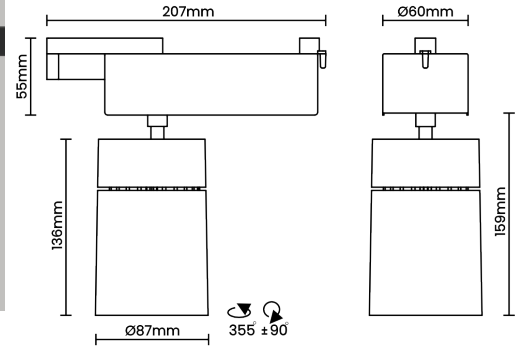

Light Distribution

LED Technology

Binning 3 Step MacAdam

LED Life Time @ L80/B10 >50000 hours

Colour Rendering (CRI) CRI80,CRI90

Led Type COB

LED Fitted Cree COB LED 33V-36Vdc/500mA

Controls

Standard Switchable On/Off

Optional DDIM,BTTM,CASAMBI