

# T Zee Dropdown MPD 180 | 60W

## Product Reference

Environment Indoor

Installation Ceiling Recess

## Construction & Materials

Housing Extruded and Sheet Aluminium

Primary Lens -

Primary Reflector White Optics

Secondary Reflector -

Body Finish White,Black,Custom

Diffuser Microprismatic

Antiglare Baffle -

## Thermal Management

Heat Sink Material Aluminium

Cooling Technique Passive Cooling

## Optical System

Beam Direction General Diffuse

Tilt No

Swivel No

## Electrical System

Driven with Constant Current Driver

Input Voltage/Hz 220V- 240V/50-60Hz

Control Gear Included

Mounting Integral

LED Power Watts 69.3W

System Power Watts 79.6W

Operating Voltage Vin 220-240Vac

Power Factor p.f. >0.95

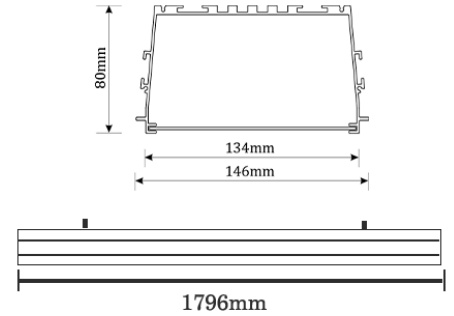

## Light Distribution

## LED Technology

Binning 3 Step MacAdam

LED Life Time @ L80/B10 >50000 hours

Colour Rendering (CRI) CRI80,CRI90

Led Type SMD mid power

LED Fitted Osram/Samsung Mid power LED array 32V-36Vdc/1500mA

## Controls

Standard Switchable On/Off

Optional PDIM,DDIM,CASAMBI,Non Dimmable

## Ordering Details

Code Example:	Name	Watt	CCT	CRI	Angle	Finish	Control
	<b>T Zee Dropdown MPD 180</b>	<b>60W</b>	<b>WW27K</b>	<b>CRI80</b>	<b>80° general diffuse</b>	<b>SWH</b>	<b>On/Off</b>

Select one from each column with highlighted values to create the ordering code

NAME	WATT	LUMEN	EFFICACY	CCT	CRI	ANGLE	FINISH	CONTROL
<b>T Zee Dropdown MPD 180</b>	<b>60W</b>	5671	95	2700K	<b>WW27K</b>	80° general diffuse	White	Non Dimmable
		5851	98	3000K	<b>WW30K</b>		Black	Phase Dimmable
		6149	103	4000K	<b>NW40K</b>		Custom	Dali Dimmable
		6269	105	5700K	<b>CW57K</b>			Casambi
				2700K-5700K	<b>TW</b>			
<b>T Zee Dropdown MPD 180</b>	<b>60W</b>			<b>WW27K</b>	<b>CRI80</b>	<b>80° general diffuse</b>	<b>SWH</b>	<b>On/Off</b>

Abby reserves the right to discontinue any product from its collection at any time whatsoever and without prior notice

[frontdesk@abbylighting.com](mailto:frontdesk@abbylighting.com), +91 9833645212

[www.abbylighting.com](http://www.abbylighting.com)