

T Zee MPD 180 | 42W

Product Reference

Environment Indoor

Installation Ceiling Recess

Construction & Materials

Housing Extruded and Sheet Aluminium

Primary Lens -

Primary Reflector White Optics

Secondary Reflector -

Body Finish White,Black,Custom

Diffuser Microprismatic

Antiglare Baffle -

Thermal Management

Heat Sink Material Aluminium

Cooling Technique Passive Cooling

Optical System

Beam Direction General Diffuse

Tilt No

Swivel No

Electrical System

Driven with Constant Current Driver

Input Voltage/Hz 220V- 240V/50-60Hz

Control Gear Included

Mounting Integral

LED Power Watts 36.0W

System Power Watts 41.4W

Operating Voltage Vin 220-240Vac

Power Factor p.f. >0.95

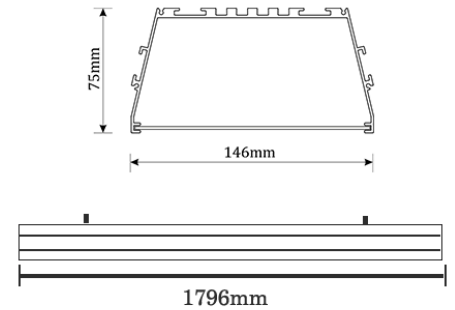
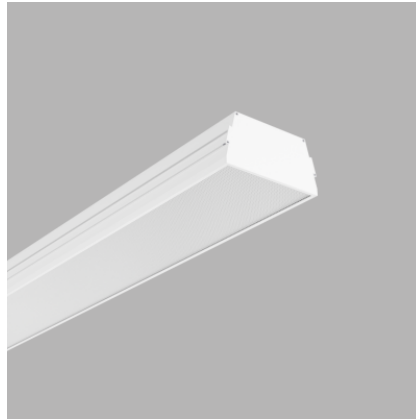

Light Distribution

LED Technology

Binning 3 Step MacAdam

LED Life Time @ L80/B10 >50000 hours

Colour Rendering (CRI) CRI80,CRI90

Led Type SMD mid power

LED Fitted Osram/Samsung Mid power LED array 32V-36Vdc/1050mA

Controls

Standard Switchable On/Off

Optional PDIM,DDIM,CASAMBI,Non Dimmable

Ordering Details

Code Example:	Name	Watt	CCT	CRI	Angle	Finish	Control
	T Zee MPD 180	42W	WW27K	CRI80	79° general diffuse	SWH	On/Off

Select one from each column with highlighted values to create the ordering code

NAME	WATT	LUMEN	EFFICACY	CCT	CRI	ANGLE	FINISH	CONTROL
T Zee MPD 180	42W	4099	99	2700K	WW27K	79° general diffuse	White	Non Dimmable
		4223	102	3000K	WW30K		Black	Phase Dimmable
		4430	107	4000K	NW40K		Custom	Dali Dimmable
		4513	109	5700K	CW57K			Casambi
				2700K-5700K	TW			
T Zee MPD 180	42W			WW27K	CRI80	79° general diffuse	SWH	On/Off