

Sigma 60 | 10W

Product Reference

Environment Indoor

Installation Ceiling Recess

Construction & Materials

Housing Aluminium

Primary Lens -

Primary Reflector PC metallised

Secondary Reflector Anodised

Body Finish White,Black

Diffuser -

Antiglare Baffle -

Thermal Management

Heat Sink Material Die cast Aluminium

Cooling Technique Passive Cooling

Optical System

Beam Direction Fixed

Tilt No

Swivel No

Electrical System

Driven with Constant Current Driver

Input Voltage/Hz 220V- 240V/50-60Hz

Control Gear Included

Mounting Integral

LED Power Watts 8.8W

System Power Watts 10.1W

Operating Voltage Vin 220-240Vac

Power Factor p.f. >0.95

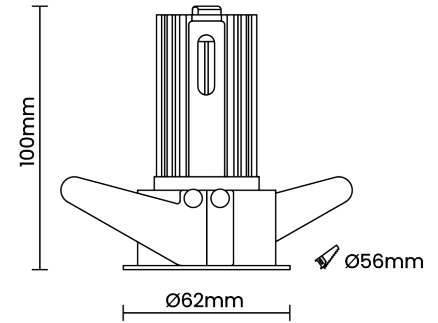
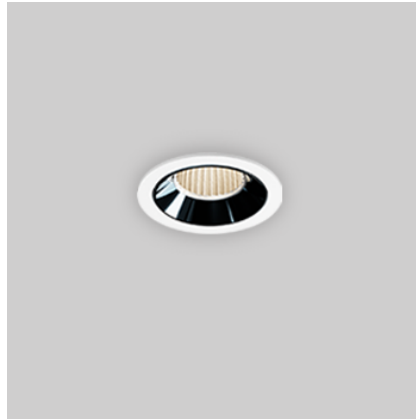

Light Distribution

LED Technology

Binning 3 Step MacAdam

LED Life Time @ L80/B10 >50000 hours

Colour Rendering (CRI) CRI80,CRI90

Led Type COB

LED Fitted Cree COB LED 33V-36Vdc/250mA

Controls

Standard Switchable On/Off

Optional DDIM

Ordering Details

Code Example:	Name	Watt	CCT	CRI	Angle	Finish	Control
	Sigma 60	10W	WW27K	CRI80	29°(MD)	SWH	On/Off

Select one from each column with highlighted values to create the ordering code

NAME	WATT	LUMEN	EFFICACY	CCT		CRI	ANGLE		FINISH		CONTROL	
Sigma 60	10W	788	78	2700K	WW27K	CRI80	29°(MD)	29°(MD)	White	SWH	Non Dimmable	On/Off
		808	80	3000K	WW30K	CRI90	42°(WD)	42°(WD)	Black	SBL	Dali Dimmable	DDIM
		848	84	4000K	NW40K		62°(VWD)	62°(VWD)				
		869	86	5700K	CW57K							
Sigma 60	10W			WW27K	CRI80		29°(MD)		SWH		On/Off	