

Sixty6 P 60 | 34W

Product Reference

Environment Indoor

Installation Ceiling Suspended

Construction & Materials

Housing Extruded and Sheet Aluminium

Primary Lens -

Primary Reflector White Optics

Secondary Reflector -

Body Finish White,Black,Custom

Diffuser Opal PC, Microprismatic

Antiglare Baffle -

Thermal Management

Heat Sink Material Aluminium

Cooling Technique Passive Cooling

Optical System

Beam Direction General Diffuse

Tilt No

Swivel No

Electrical System

Driven with Constant Current Driver

Input Voltage/Hz 220V- 240V/50-60Hz

Control Gear Included

Mounting Integral

LED Power Watts 28.9W

System Power Watts 33.2W

Operating Voltage V_{in} 220-240 Vac

Power Factor p.f. > 0.95

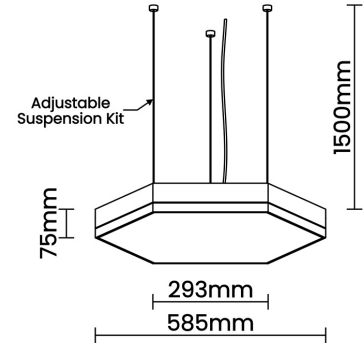

Light Distribution

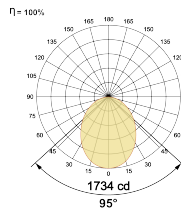

LED Technology

Binning 3 Step MacAdam

LED Life Time @ L80/B10 >50000 hours

Colour Rendering (CRI) CRI80,CRI90

Led Type SMD mid power

LED Fitted Osram/Samsung Mid power LED array 42V-48Vdc/700mA

Controls

Standard Switchable On/Off

Optional DDIM,CASAMBI,Non Dimmable

Ordering Details

Code Example:	Name	Watt	CCT	CRI	Angle	Finish	Control
	Sixty6 P 60	34W	WW27K	CRI80	95°	SWH	On/Off

Select one from each column with highlighted values to create the ordering code

NAME	WATT	LUMEN	EFFICACY	CCT	CRI	ANGLE	FINISH	CONTROL
Sixty6 P 60	34W	3818	115	2700K	WW27K	95°	White	Non Dimmable
		3906	118	3000K	WW30K		Black	Dali Dimmable
		4183	126	4000K	NW40K		Custom	Casambi
		4316	130	5700K	CW57K			
Sixty6 P 60	34W			WW27K	CRI80	95°	SWH	On/Off

